



**EVOTECH**®  
P E R F O R M A N C E

Ducati Scrambler 1100  
Tail Tidy

Installation Instructions



## Kit Contents PRN014118

- (A) 1 x Reflector Kit
- (B) 1 x P-Clip
- (C) 1 x M4 x 8mm Black Button Head Bolts
- (D) 2 x M4 x 10mm Capheads
- (E) 2 x M5 x 12mm C/Sink
- (F) 2 x Spacer (Rear Light Spacer)
- (G) 2 x Spacer
- (H) 4 x M6 x 16mm Black Button Head Bolts

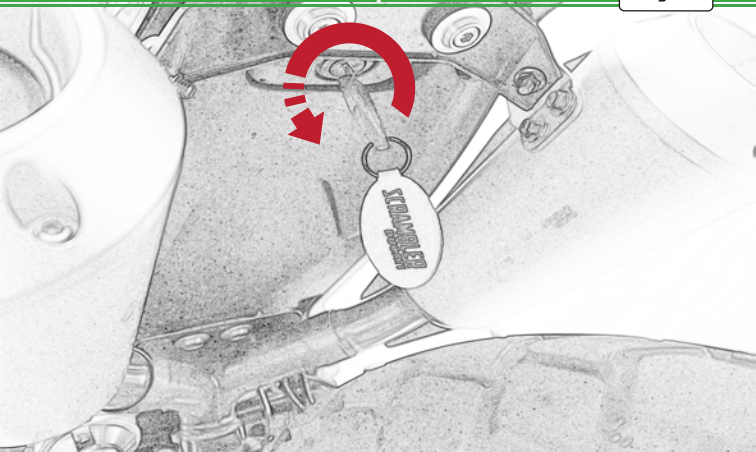

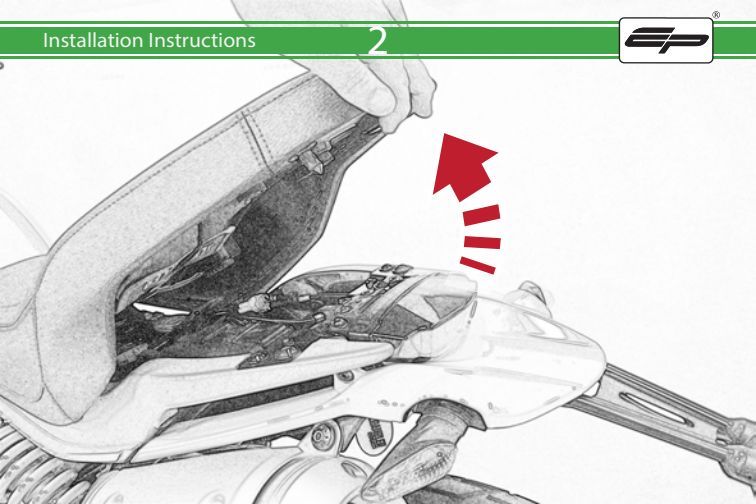

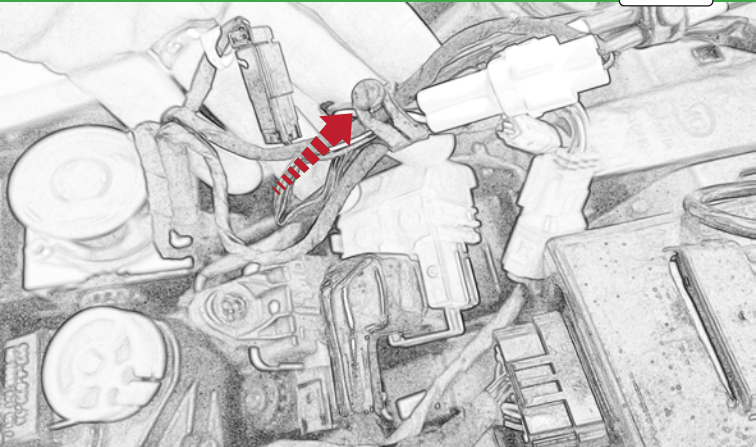

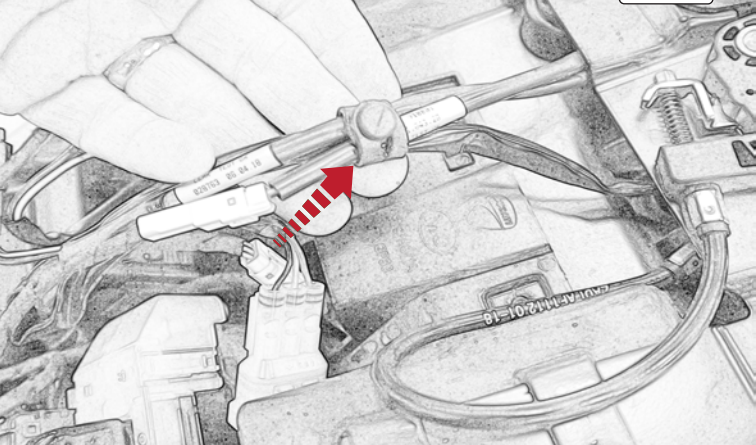

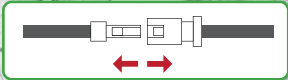
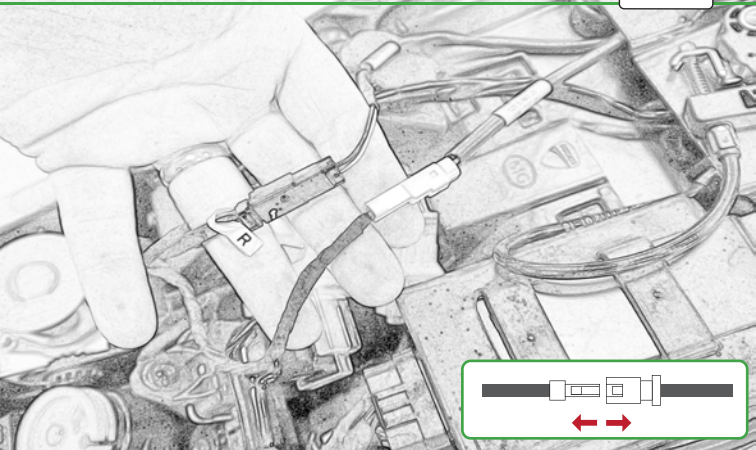

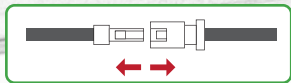
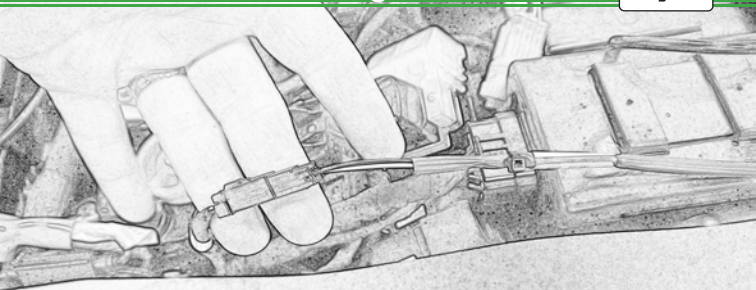



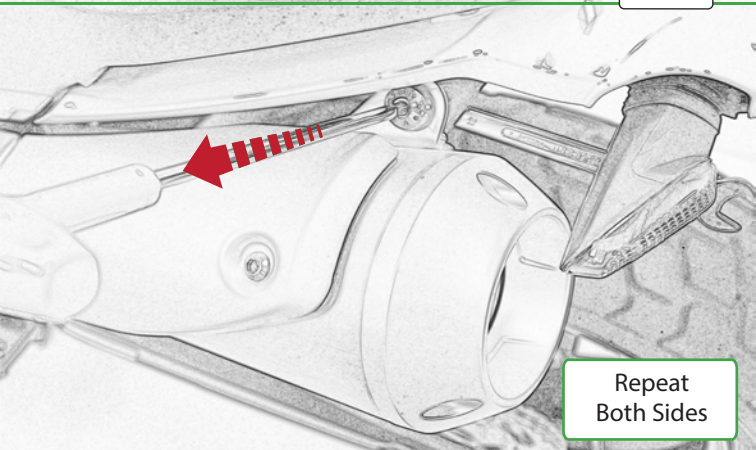

Repeat  
Both Sides

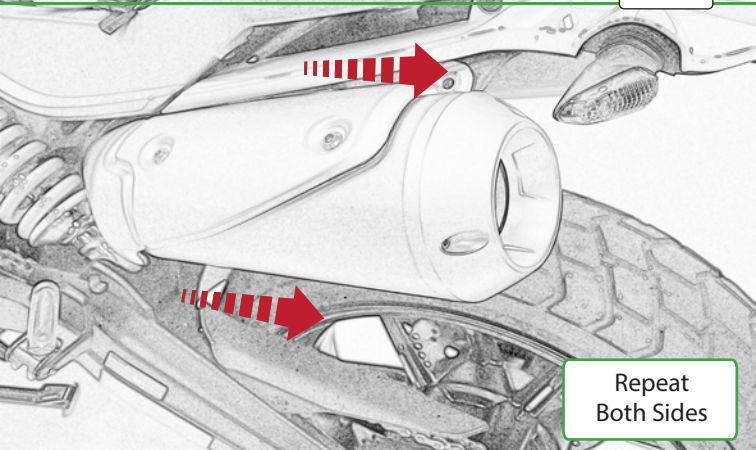

Repeat  
Both Sides

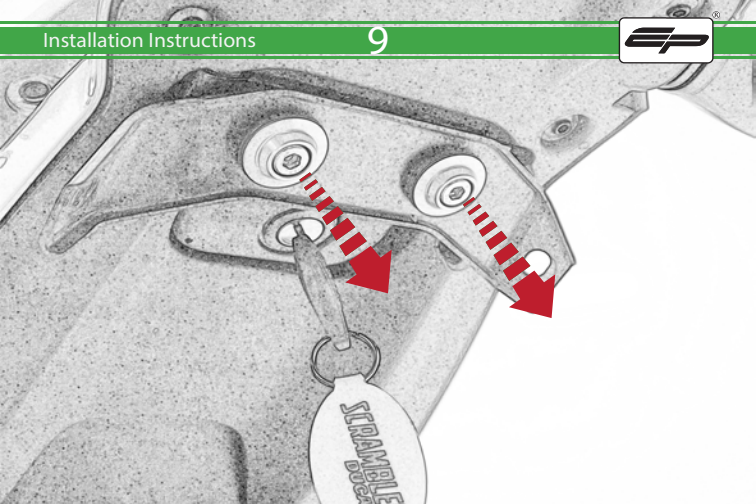

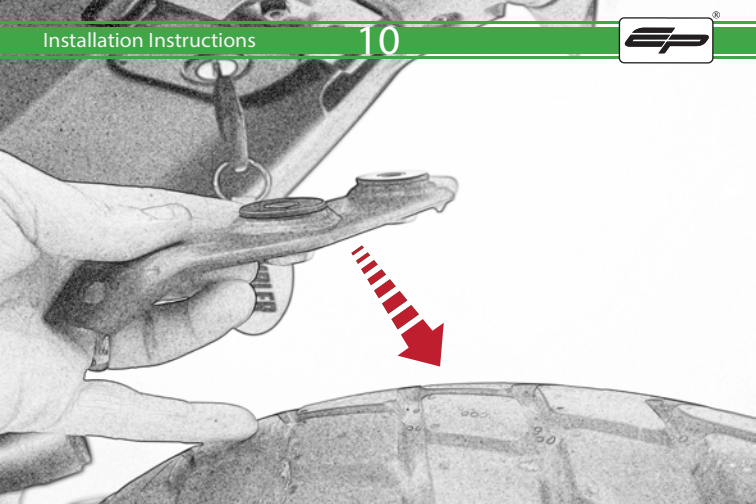

## Installation Instructions

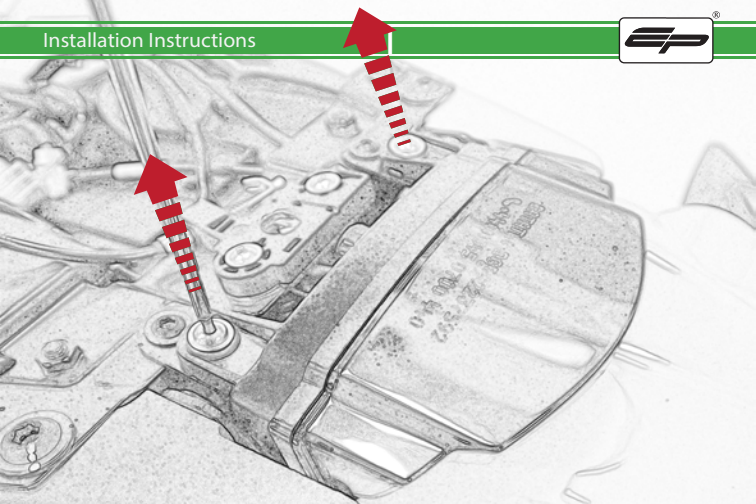



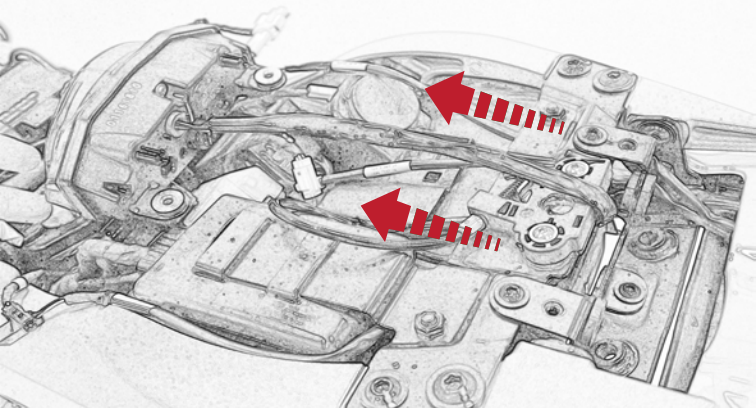

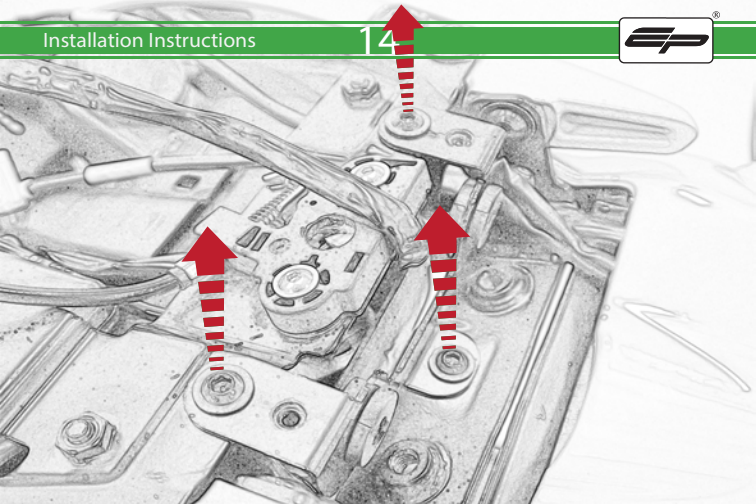



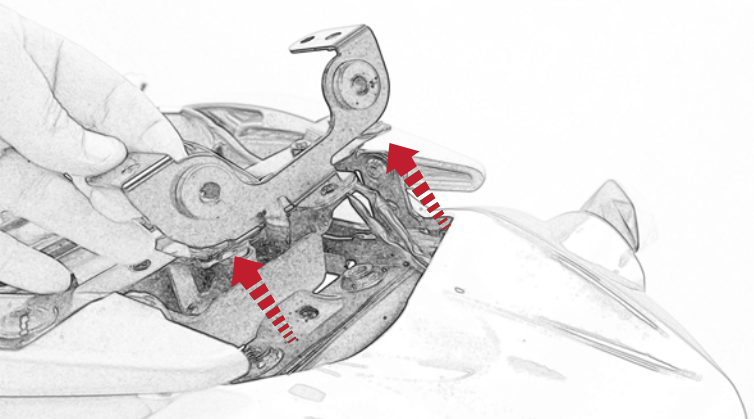

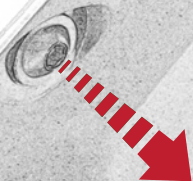

Repeat  
Both Sides

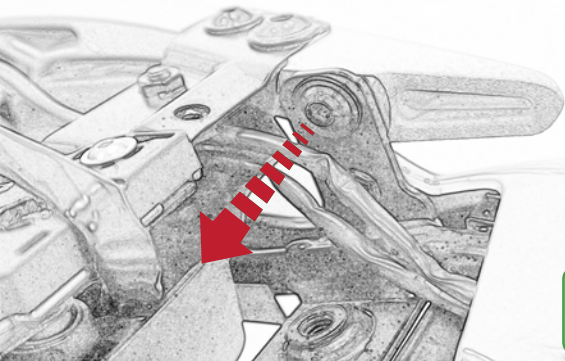

Repeat  
Both Sides

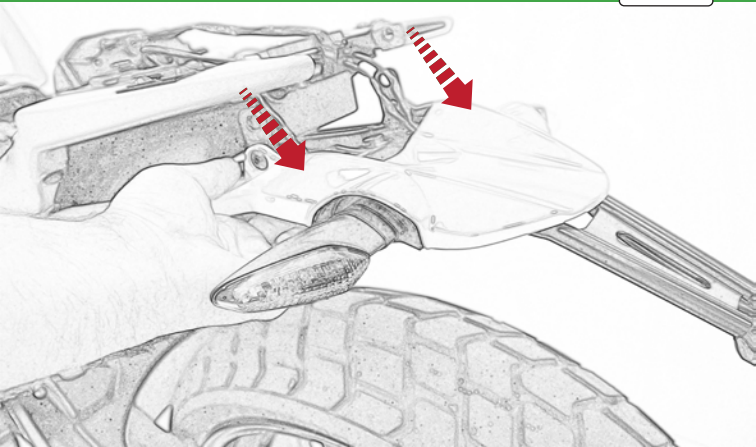

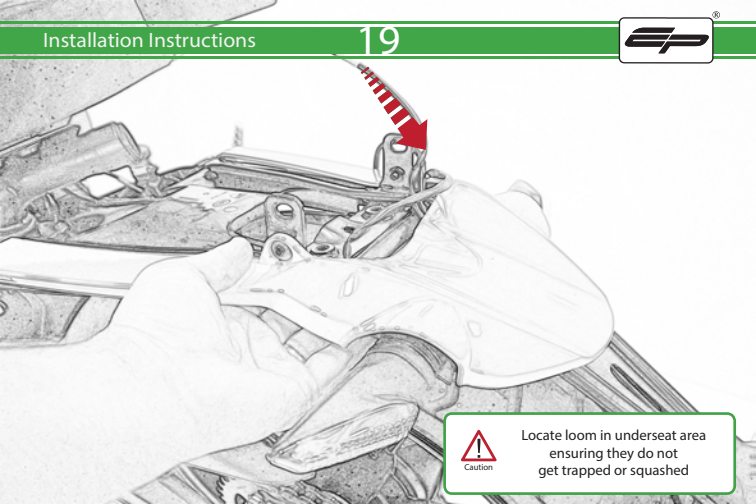

Caution

Locate loom in underseat area  
ensuring they do not  
get trapped or squashed



Repeat  
Both Sides

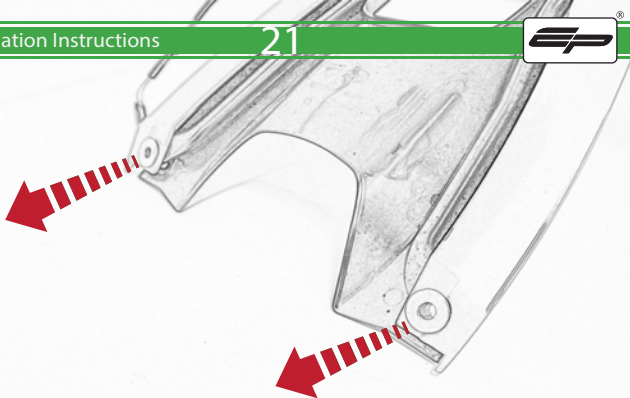

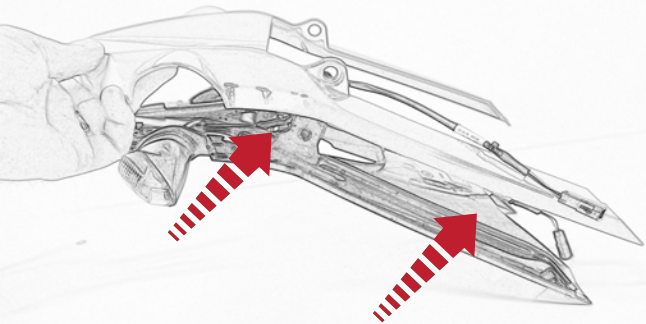



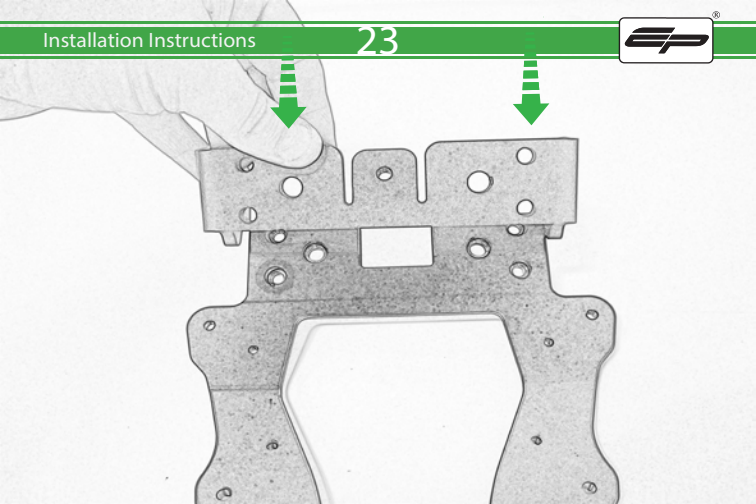

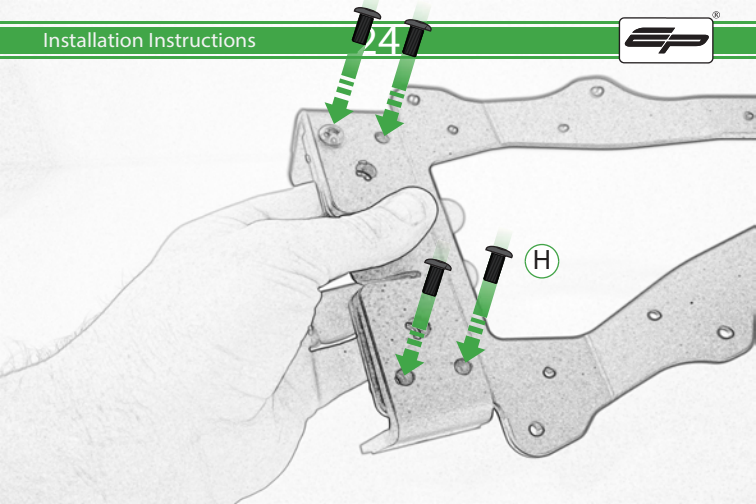

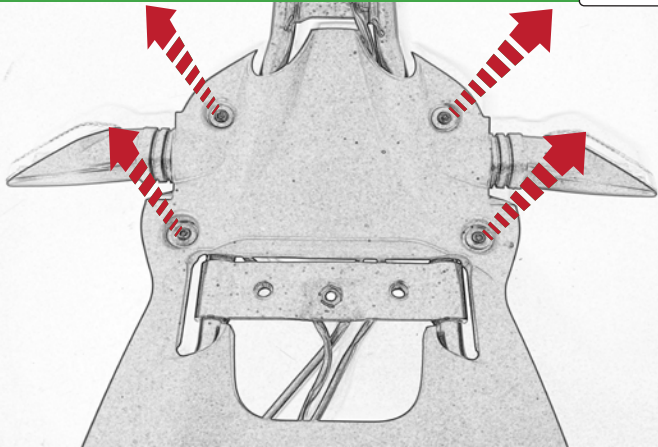

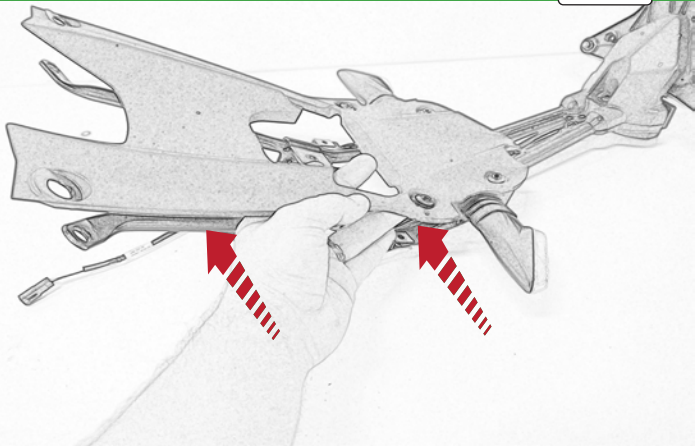

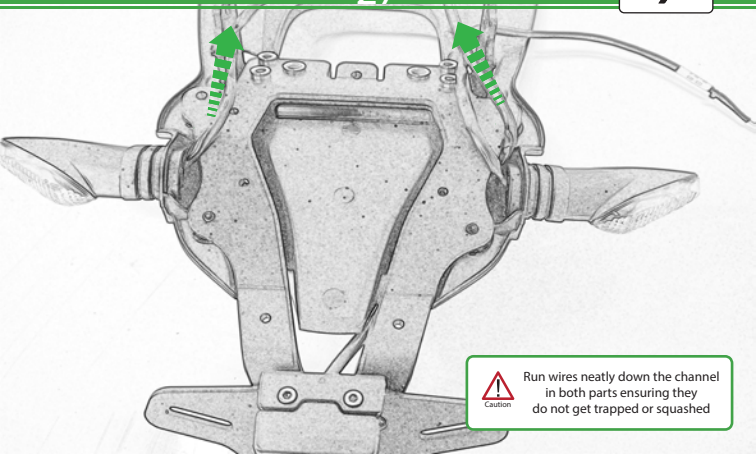

Caution

Run wires neatly down the channel in both parts ensuring they do not get trapped or squashed

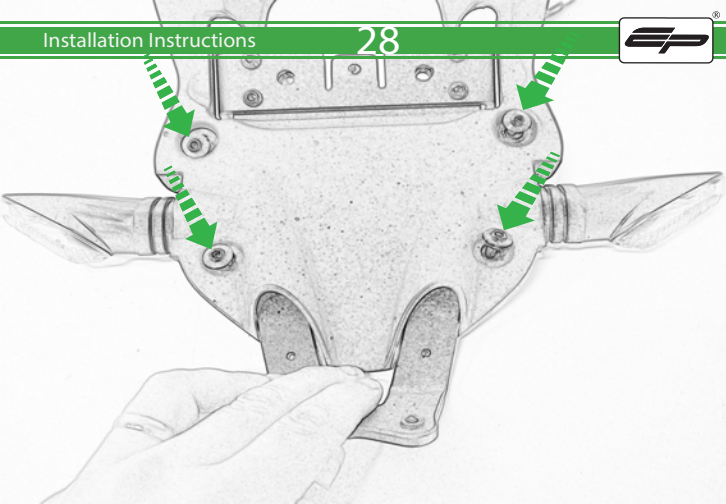

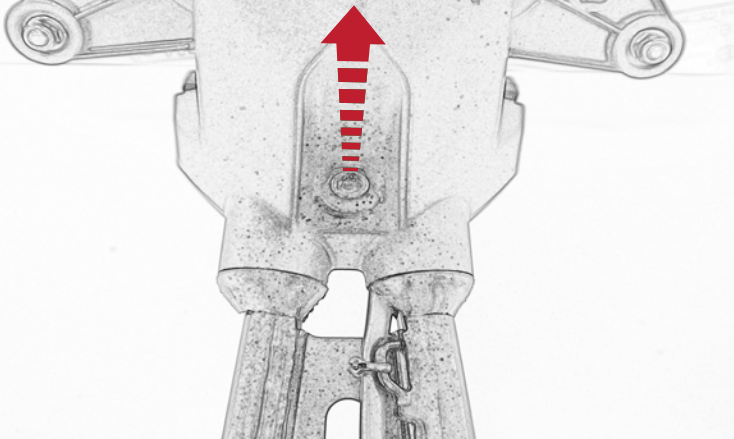

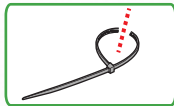
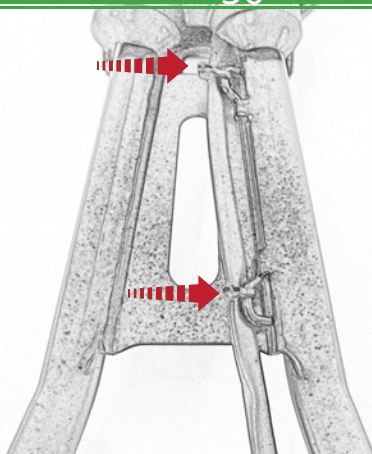



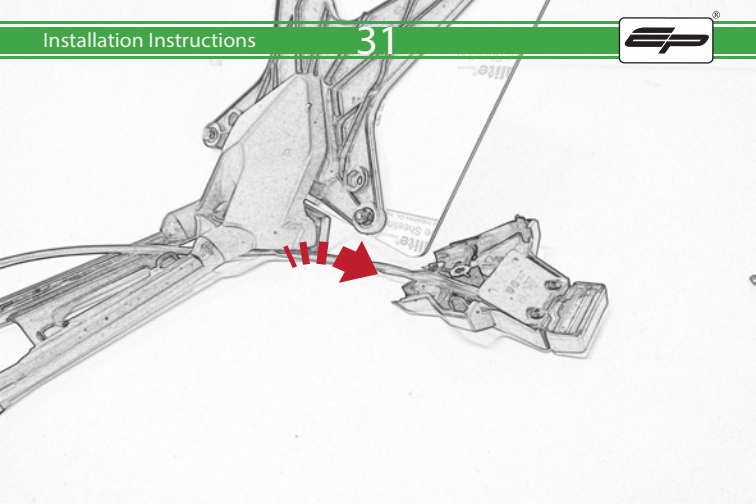

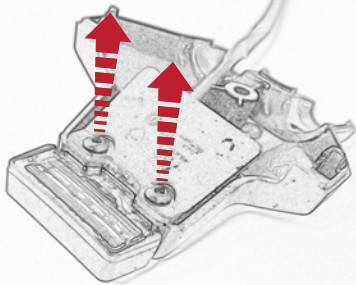

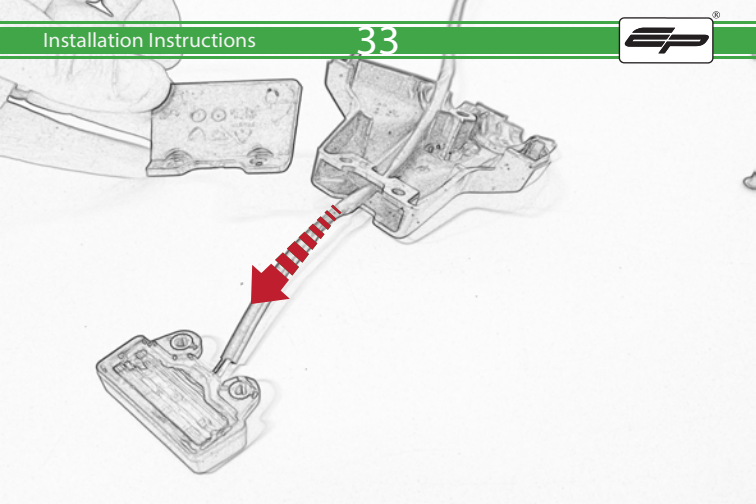

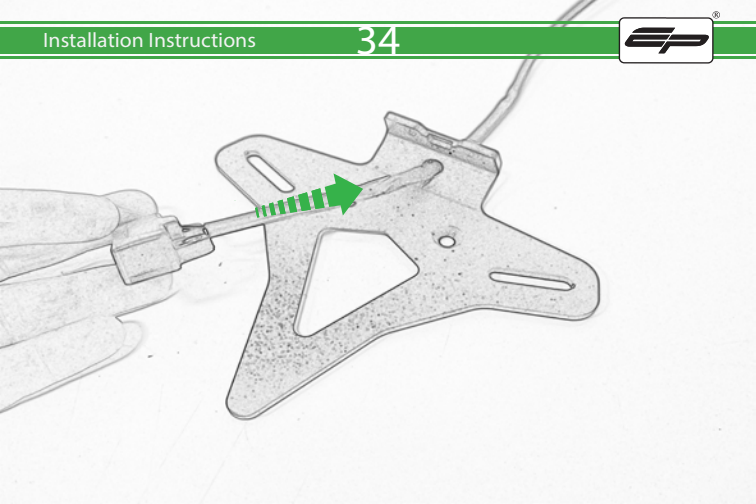

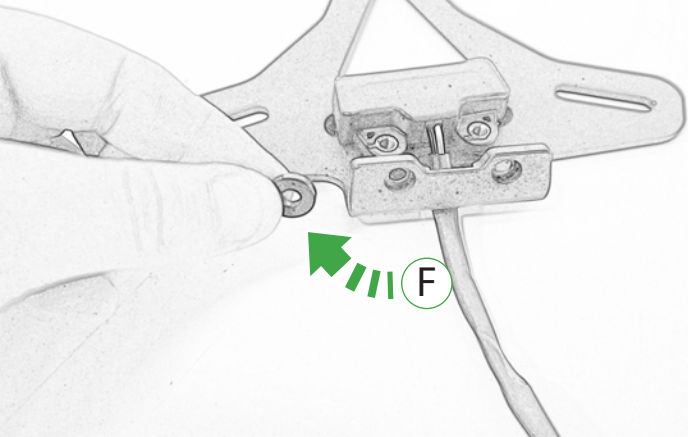

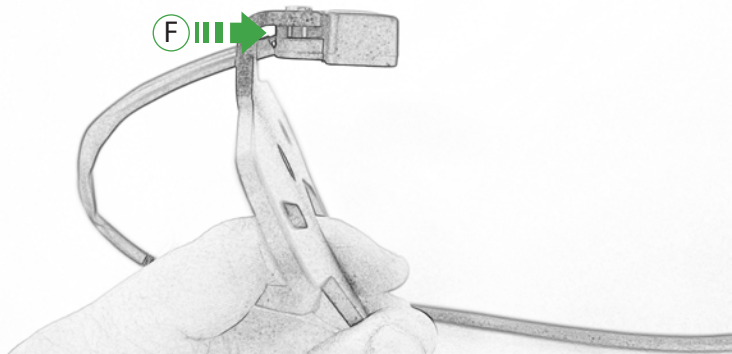

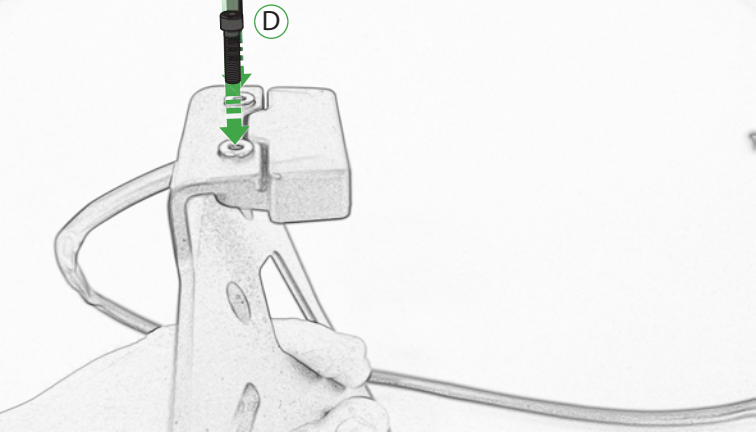

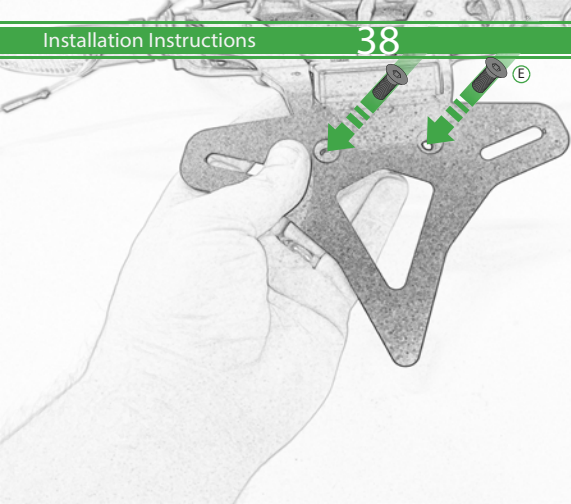



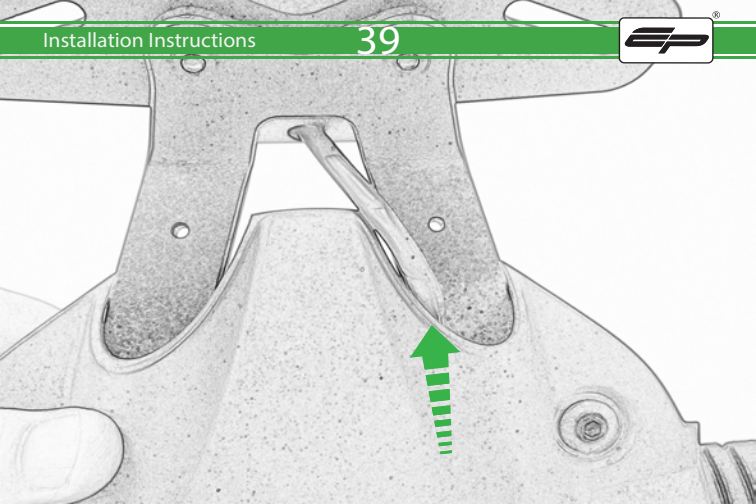

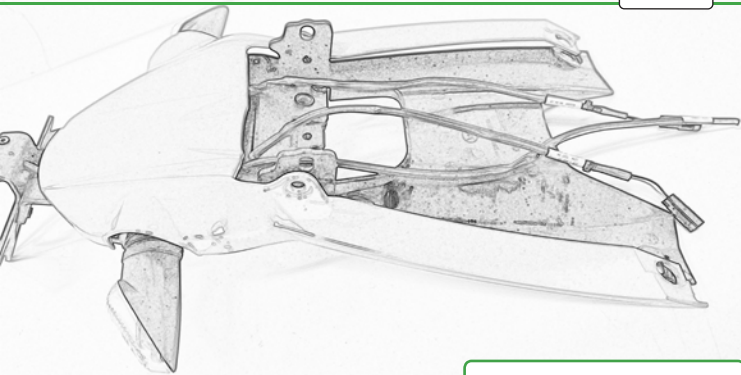

Run wires neatly down the channel  
in both parts ensuring they  
do not get trapped or squashed



OEM PART

The diagram shows a close-up of a vehicle's front suspension assembly. A steering knuckle is being inserted into a hub assembly. A green arrow with white diagonal stripes points from a callout box labeled 'OEM PART' to the steering knuckle. Another green arrow with white diagonal stripes points from a callout box labeled 'Repeat Both Sides' to the steering knuckle. The background is a light gray, semi-transparent image of the vehicle's chassis.

Repeat  
Both Sides



B

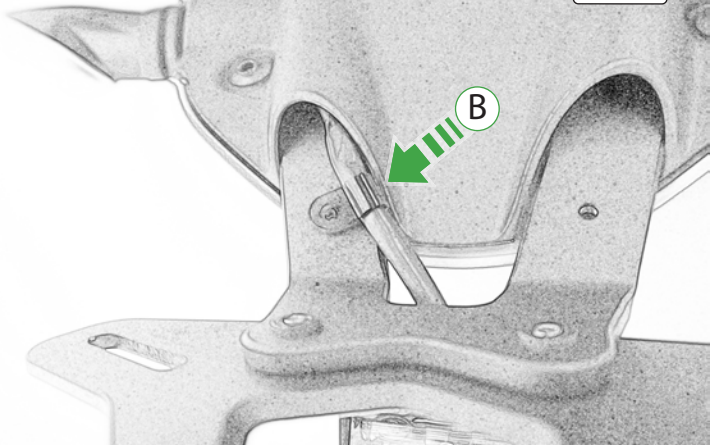



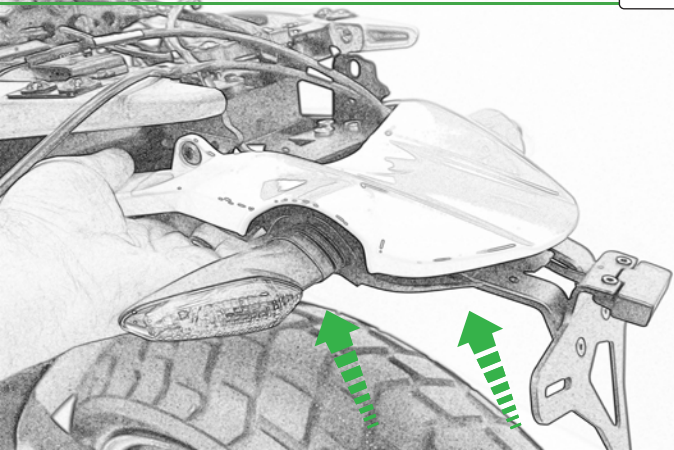

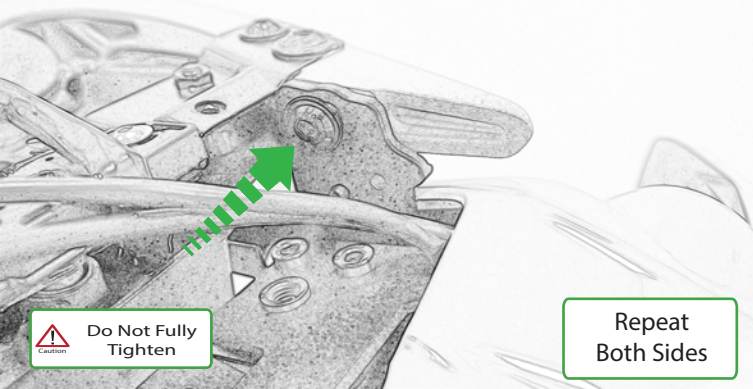

Do Not Fully  
Tighten

Repeat  
Both Sides



Do Not Fully Tighten



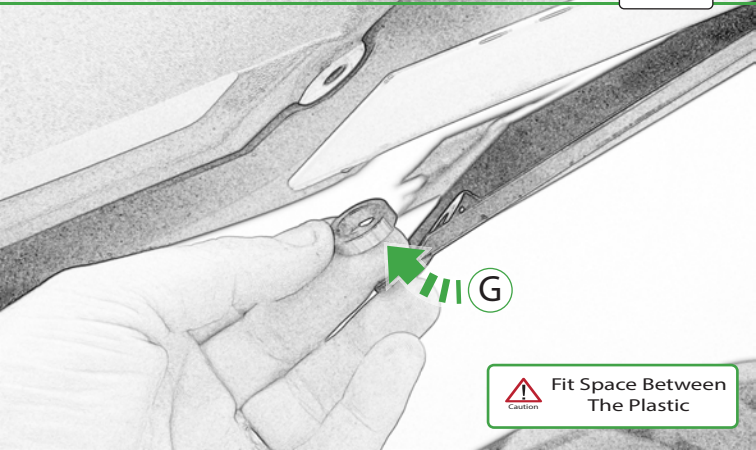

G



Fit Space Between  
The Plastic

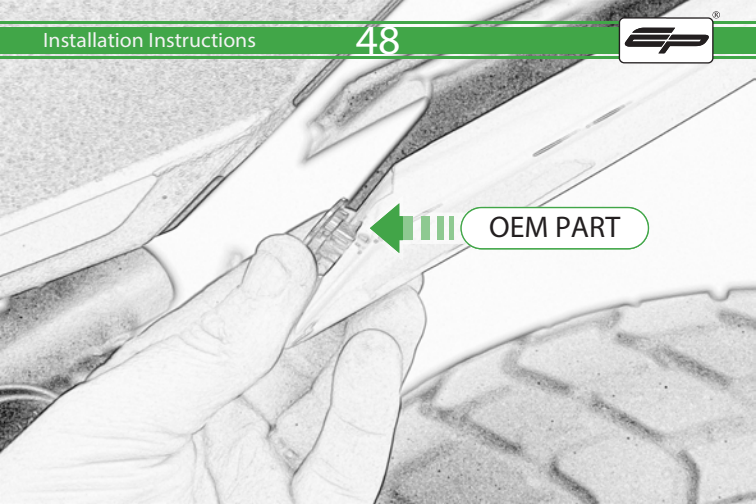

OEM PART

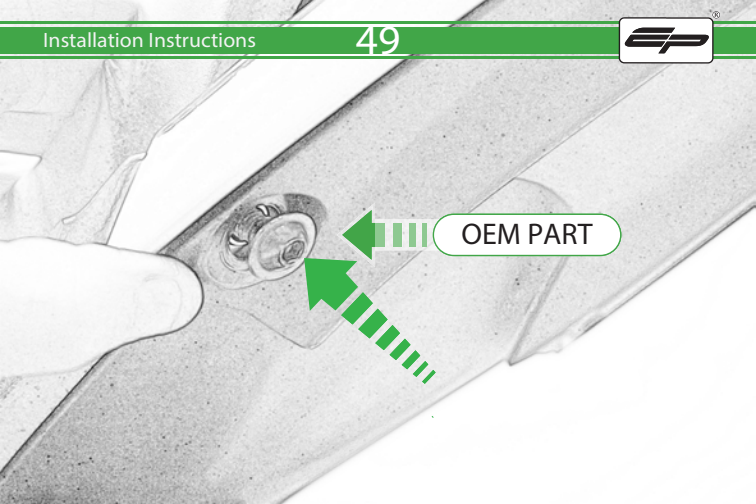

OEM PART

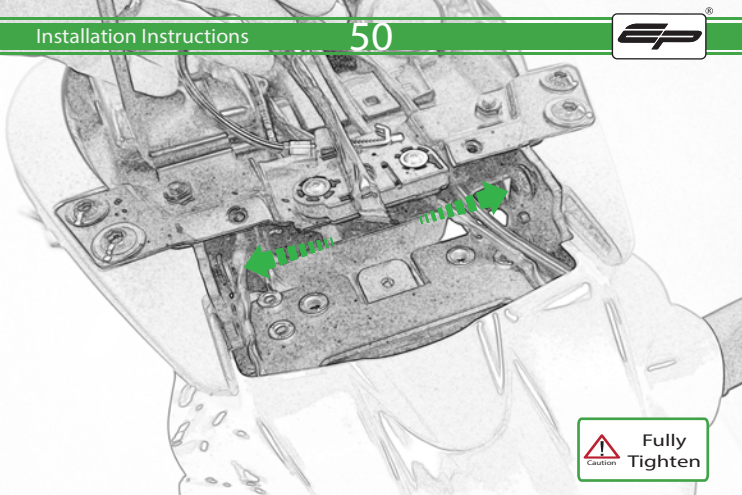

 Fully Tighten

The text 'Fully Tighten' is positioned to the right of a triangular warning icon. The icon contains a black exclamation mark and the word 'Caution' in small text below it. The entire text and icon are enclosed in a green rectangular border.

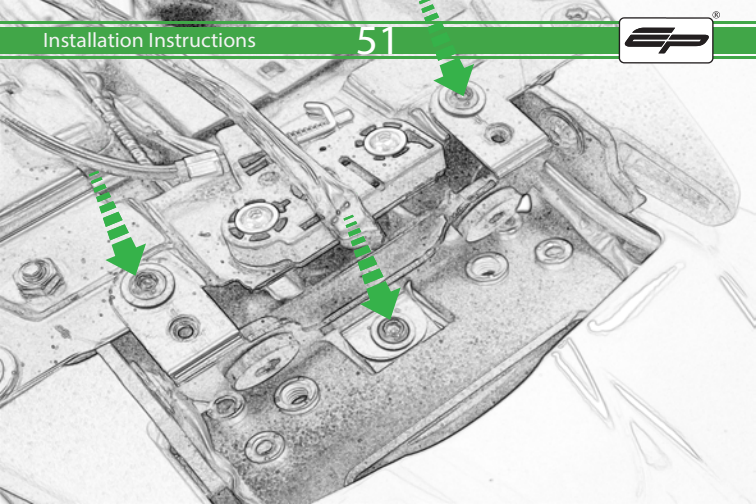

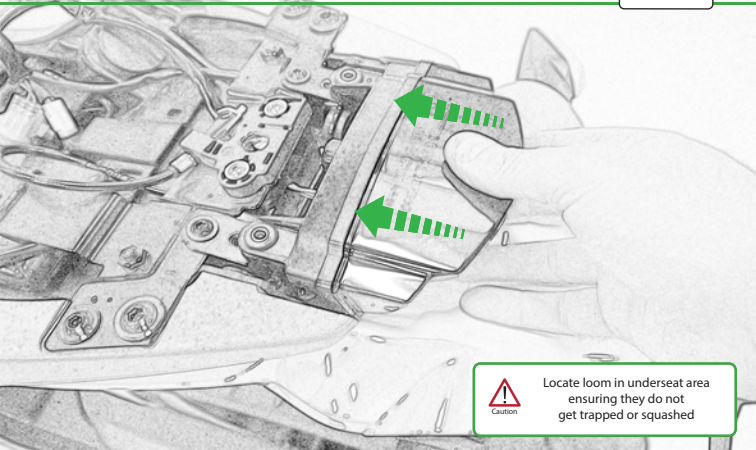

Locate loom in underseat area  
ensuring they do not  
get trapped or squashed



OEM PART

OEM PART



Locate loom in underseat area  
ensuring they do not  
get trapped or squashed

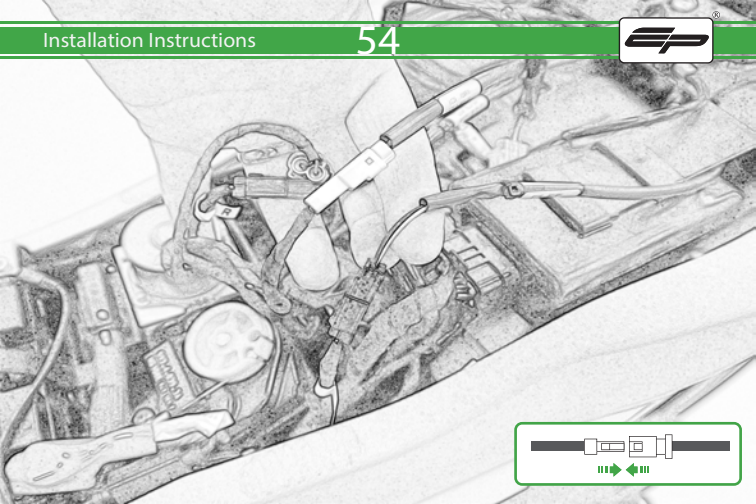





Reverse Stages

10 - 7

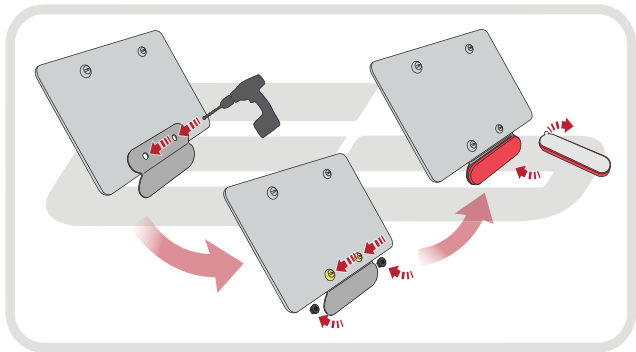

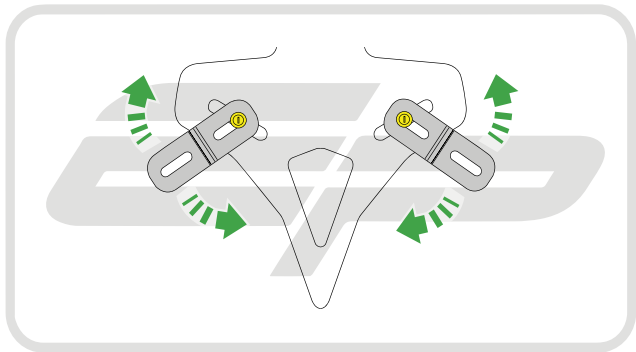



 **ESSENTIAL CHECKS** 

After installation of your tail tidy ensure that the licence plate does not contact the rear tyre when suspension is fully compressed.

Ensure all electrics including indicators, tail light, brake light and licence plate light lights are working correctly before riding the motorcycle.

It is recommended that periodic inspections are made to ensure that all fixings are fully tightend.



**EVOTECH**®  
P E R F O R M A N C E

[www.evotech-performance.com](http://www.evotech-performance.com)